



HEDGE-A-MATIC

curve curve curve



*create shapes!
define spaces...*

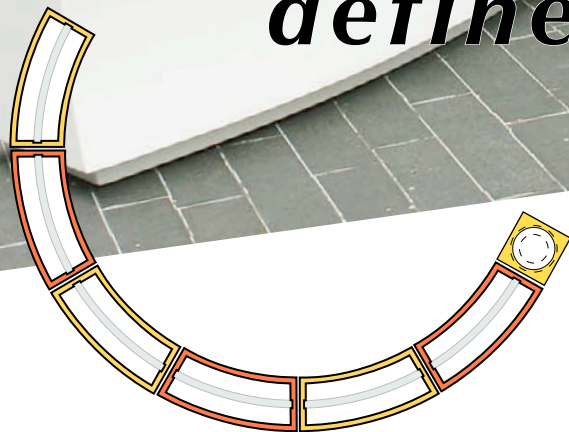

curve

use combinations

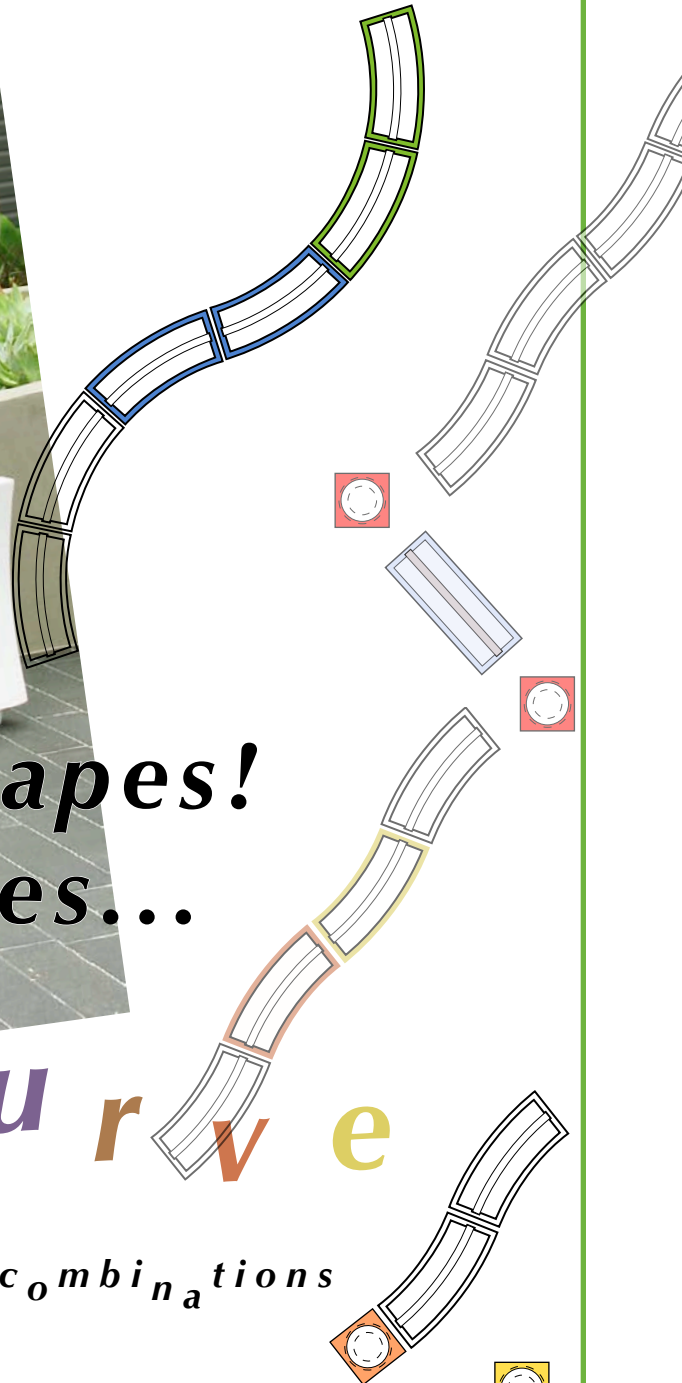

greenscreen®

1743 S. LA CIENEGA BLVD. LOS ANGELES, CA 90035 T - 800.450.3494

www.greenscreen.com





HEDGE - A - MATIC

curved rectangular

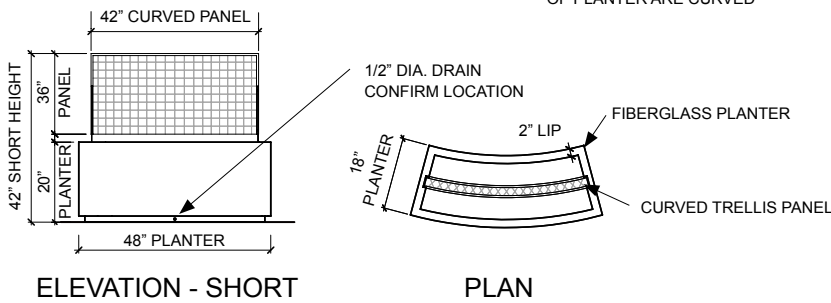
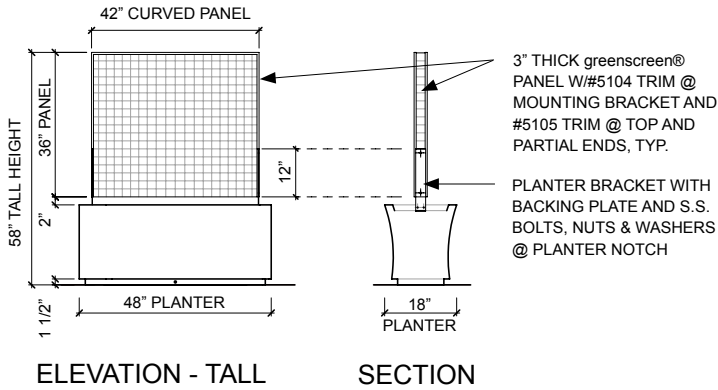
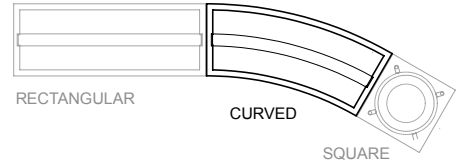

(2) PANEL OPTIONS:
36" TALL WITH FLAT TOP
20" SHORT WITH FLAT TOP



ORDERING:

Hedge-A-Matic / Curved Rectangular Planter with "short curved" greenscreen® trellis panel.

Planter size 48" w x 18" d x 20" h.
Finished height of assembled unit is 42".

Hedge-A-Matic / Curved Rectangular Planter with "tall curved" greenscreen® trellis panel.

Planter size 48" w x 18" d x 20" h.
Finished height of assembled unit is 58".

Hedge-A-Matic / Curved Rectangular Planter without greenscreen® trellis panel.

Planter size 48" w x 18" d x 20" h.

COLORS: Planters: Choose from 21 colors, four texture/finishes: Gloss, Orange Peel, Sand, Matte
Trellis screens: Choose from green, silver, black or white.

SHIPPING: F.O.B. Orange, CA. Some easy assembly required.

SPECIFICATIONS:

Fiberglass Planter with powder coated greenscreen® trellis

Weight:

Planter + screen without soil = 34 lbs.

Planter + screen with soil = 144 lbs.

Soil volume: 5.5 cu.ft.

Drainage: 1/2" NPT drainage plug included.

Planters can be fitted with a perforated sub-floor/water reservoir.

greenscreen®

1743 S. LA CIENEGA BLVD. LOS ANGELES, CA 90035 T - 800.450.3494

www.greenscreen.com

c2



HEDGE-A-MATIC

rectangular

rectangular

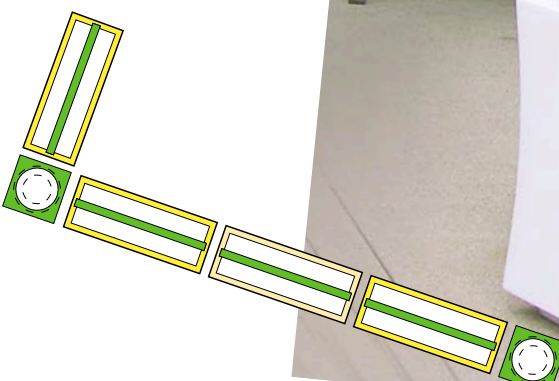
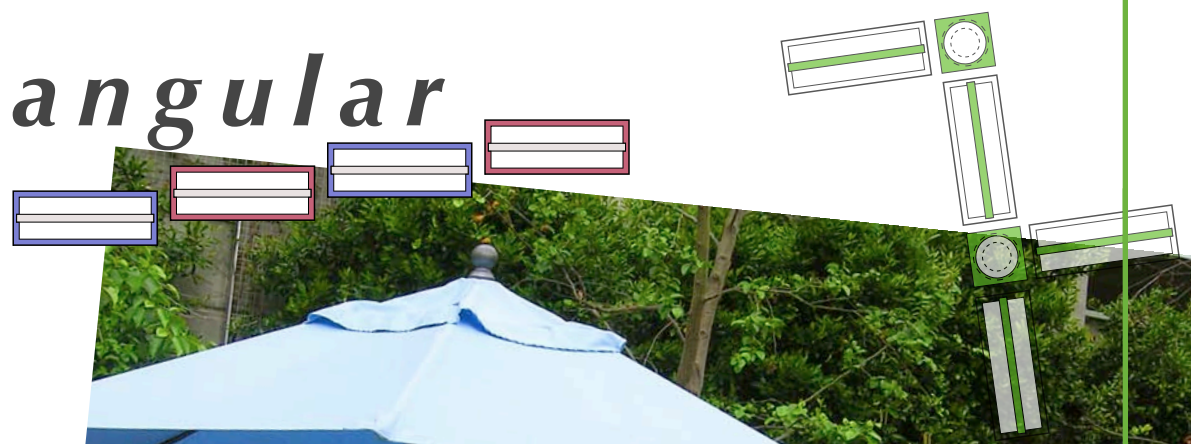

*use for privacy!
define spaces...*

use combinations

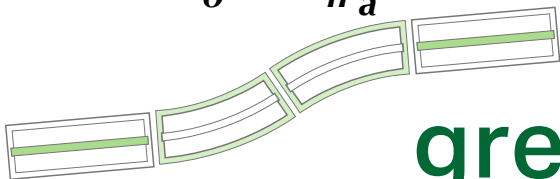

greenscreen®

1743 S. LA CIENEGA BLVD. LOS ANGELES, CA 90035 T - 800.450.3494

www.greenscreen.com





HEDGE - A - MATIC

rectangular

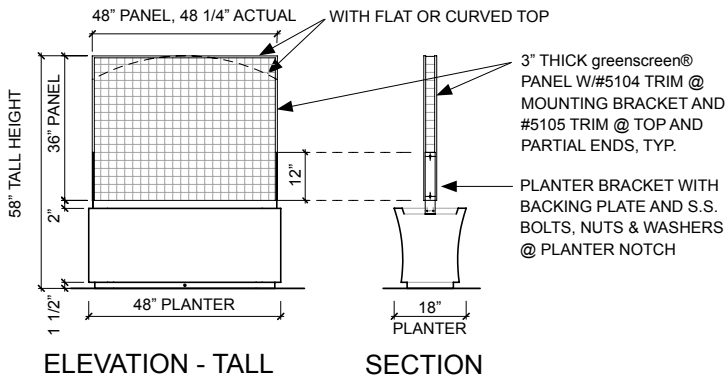
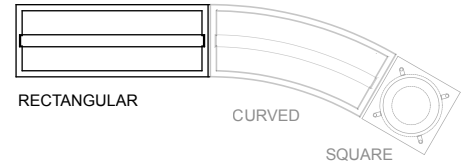

(4) PANEL OPTIONS:

- 36" TALL WITH FLAT TOP
- 36" TALL WITH CURVED TOP
- 20" SHORT WITH CURVED TOP
- 20" SHORT WITH FLAT TOP

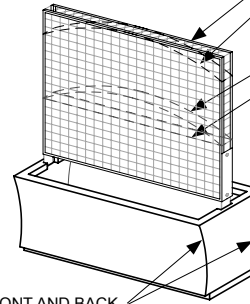

NOTE: FRONT AND BACK OF PLANTER ARE CURVED

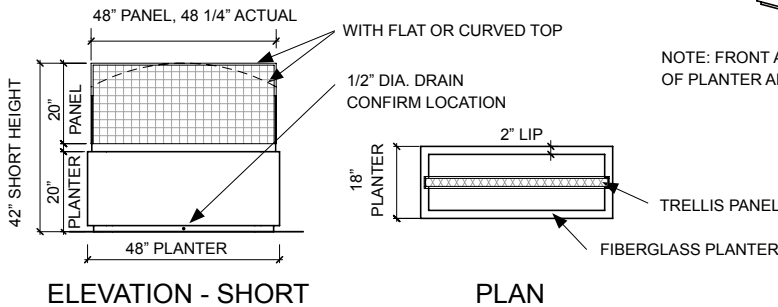

ORDERING:

Hedge-A-Matic / Rectangular Planter with "short curved top" greenscreen trellis panel.

Planter size 48"w x 18"d x 20"h. Finished height of assembled unit 42".

Hedge-A-Matic / Rectangular Planter with "tall curved top" greenscreen trellis panel.

Planter size 48"w x 18"d x 20"h. Finished height of assembled unit 58".

Hedge-A-Matic / Rectangular Planter with "short flat top" greenscreen trellis panel.

Planter size 48"w x 18"d x 20"h. Finished height of assembled unit is 42".

Hedge-A-Matic / Rectangular Planter with "tall flat top" greenscreen trellis panel.

Planter size 48"w x 18"d x 20"h. Finished height of assembled unit 58".

Hedge-A-Matic / Rectangular Planter without greenscreen trellis panel.

Planter size 48"w x 18"d x 20"h

COLORS: Planters: Choose from 21 colors, four texture/finishes: Gloss, Orange Peel, Sand, Matte

Trellis screens: Choose from green, silver, black or white.

SHIPPING: F.O.B. Orange, CA. Some easy assembly required.

SPECIFICATIONS:

Fiberglass Planter with powder coated greenscreen® trellis

Weight:

Planter + screen without soil = 36 lbs.

Planter + screen with soil = 161 lbs.

Soil volume: 6.2 cu.ft.

Drainage: 1/2" NPT drainage plug included.

Planters can be fitted with a perforated sub-floor/water reservoir.

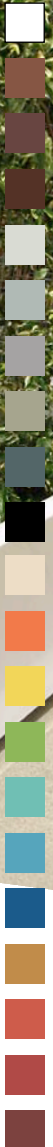

greenscreen®

1743 S. LA CIENEGA BLVD. LOS ANGELES, CA 90035 T - 800.450.3494

www.greenscreen.com



HEDGE - A - MATIC



square

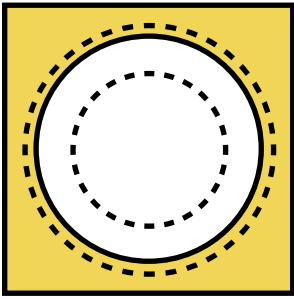

square

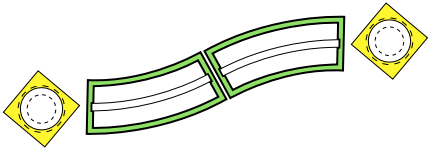
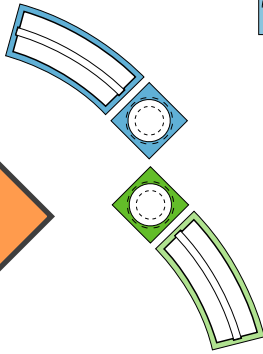
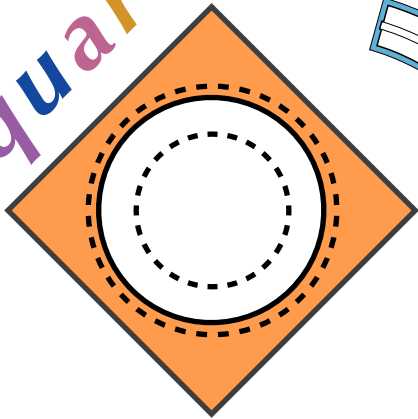

*flexibility and
accent...*

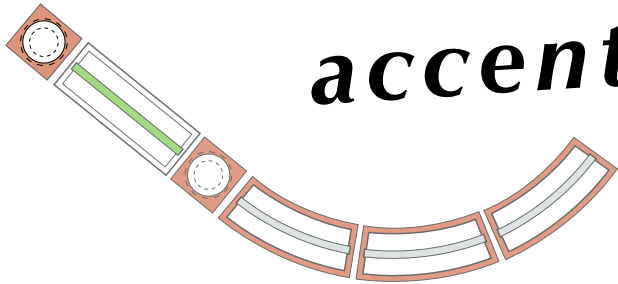

use *c o m b i n a t i o n s*

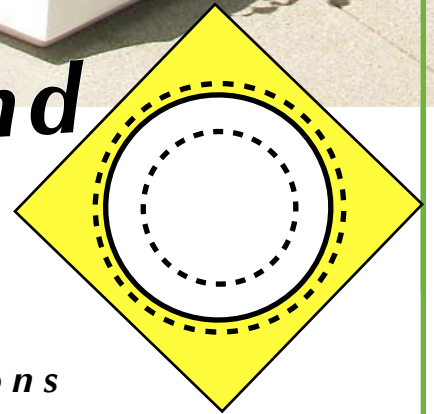

greenscreen®



HEDGE - A - MATIC

square

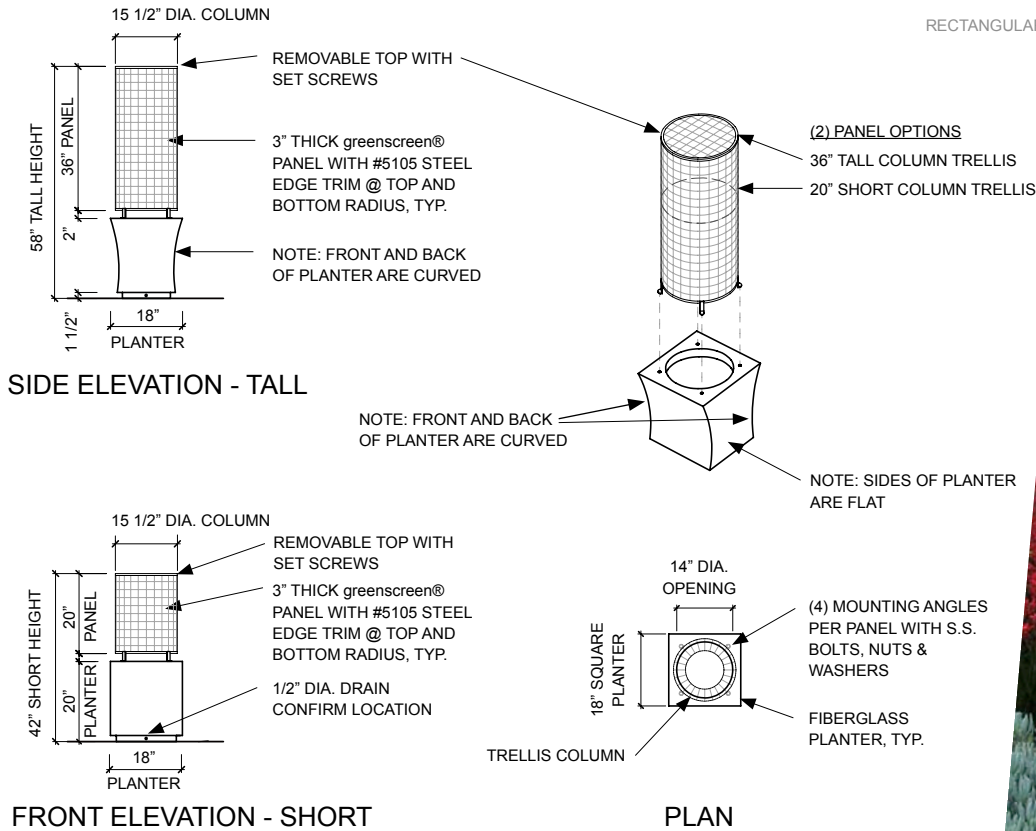
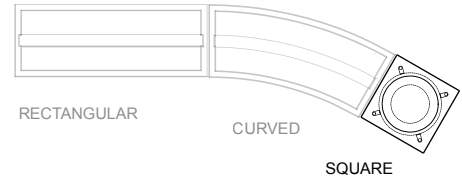

ORDERING:

Hedge-A-Matic Square Planter with "short" greenscreen trellis column.

Planter size 18" x 18" x 20"h. Finished height of assembled unit 42".

Hedge-A-Matic Square Planter with "tall" greenscreen trellis column.

Planter size 18" x 18" x 20"h. Finished height of assembled unit 58".

Hedge-A-Matic Square Planter without greenscreen trellis column.

Planter size 18" x 18" x 20"h.

COLORS: Planters: Choose from 21 colors, four texture/finishes: Gloss, Orange Peel, Sand, Matte
Trellis screens: Choose from green, silver, black or white.

SHIPPING: F.O.B. Orange, CA. Some easy assembly required.

SPECIFICATIONS:

Fiberglass Planter with powder coated greenscreen® trellis

Weight:

Planter + screen without soil = 24 lbs.

Planter + screen with soil = 72 lbs.

Soil volume: 2.4 cu.ft.

Drainage: 1/2" NPT drainage plug included.

Planters can be fitted with a perforated sub-floor/water reservoir.

greenscreen®

1743 S. LA CIENEGA BLVD. LOS ANGELES, CA 90035 T - 800.450.3494

www.greenscreen.com